

Article number: 435700006

Description: Rota-fix shaft-hub connection K 6x16

Note: Self centering. Medium torque

## Measures

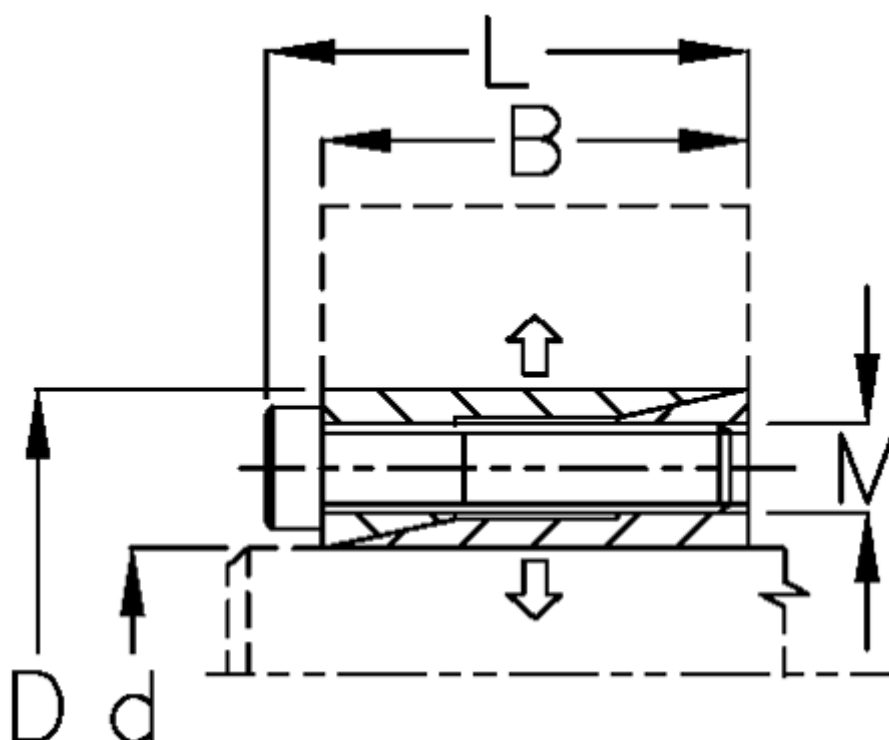

B mm	= 11
d mm	= 6.00
D mm	= 16
Fit tolerance	= Aksel h8, Nav H8
F kN torque	= 2.0
L mm	= 13.5
M mm	= M2,5
P N/mm <sup>2</sup> surface pressure on shaft/hub	= 55

Surface roughness	= R? ? 3.2 µm
T N m torque	= 6
Ts N m bolt tightening torque	= 1.2